

RADIOLOGY SUPPLIES

**IMAGING RESOURCES, INC.
POST OFFICE BOX 39
ALBANY, OREGON 97321
1-800-340-XRAY**

CATALOG

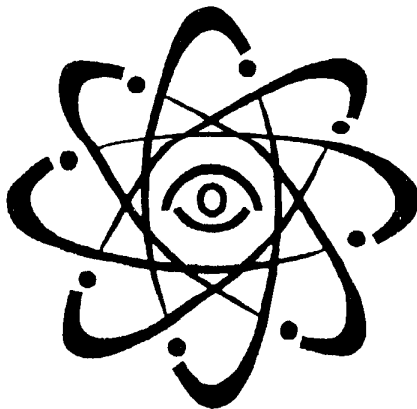

PHONE & MAIL ORDER

IMAGING RESOURCES, INC.

We are continually striving to provide the highest quality items at the lowest cost. This catalog is a sampling of the most common items we supply. If you do not find what you are looking for, please call us at 1-800-340-XRAY.

Prices subject to change without notice (ed 07/14)

Contents	
Positioning Devices	3
Protective apparel	5
Imaging Aids	7
Cassettes & Screens	10
Darkroom Aids	12
Speculums	13
Equine Radiology	14
Order Form	15

POSITIONING DEVICES

PET-SITIONER®

Designed by veterinarians

Two 12" velcro strips on each end

Unique deep V shape holds pets in place

Stain-resistant, rugged nylon cover

Cover easily removed for cleaning

Large - 36"L x 13"W x 8"H

Cat# 10035 Wt. 11 lb

Small - 24"L x 10"W x 6"H

Cat# 10036 Wt. 7 lb

Set - One each

Cat# 10037 Wt. 17 lb



FOAM SANDBAG KIT

Kit consists of:

2 - 7" x 7" - 3 lb sandbags

2 - 6" x 17" - 7 lb sandbags

2 - 7" x 24" - 12 lb sandbags

1 - 11½" x 11½" - 13 lb sandbag

Cat# 20035

SHIPPING INFO:

Flat Rate \$30.00 Shipping on sandbag kit



INDIVIDUAL PIECES:

7" x 7"

Cat# 20036 Wt. 5 lb

6" x 17"

Cat# 20037 Wt. 9 lb

7" x 24"

Cat# 20038 Wt. 13 lb

11½" x 11½"

Cat# 20039 Wt. 15 lb



POSITIONING DEVICES

COMPRESSION SAND BAG KIT:

2 - 6" x 17" sandbags, with
compression band & hooks

Cat# 20050 Wt. 16 lb



LEG BRACE

12" x 16" x 24"

(cut in half for two)

Cat# 20020 Wt. 8 lb

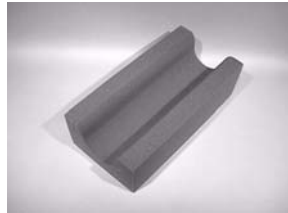

WEDGES - 22°

(2 per pack) 4" x 6" x 8"

Cat# 20025 Wt. 2 lb

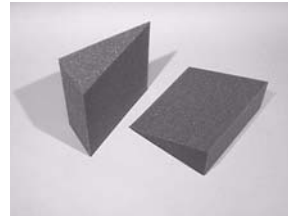

FOAM TRIANGLES

All sizes and shapes of radiolucent
foam positioning devices available.
Call with specific size requests.

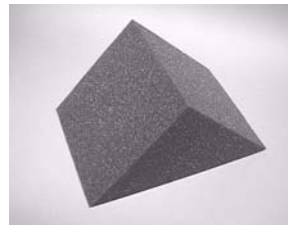

CALIPERS

Cat# 20060 Wt. 2 lb



PROTECTIVE APPAREL

PALM SLIT MITTEN STYLE LEAD GLOVES

.5mm lead equivalent

Cat# 30001 Wt. 8 lb



LEATHER COVERED FINGER STYLE LEAD GLOVES

.5mm lead equivalent

Cat# 20057 Wt. 8 lb

not pictured

VINYL COVERED FINGER STYLE LEAD GLOVES

.5mm lead equivalent

Cat# 30003 Wt. 8 lb



THYROID SHIELD

.5mm lead equivalent

Cat# 10022 Wt. 3 lb



PROTECTIVE APPAREL

LEAD APRONS

All aprons are .5mm lead equivalent

STANDARD APRON WITH TIES

Size: 22" x 38" Med

Cat#10025 Wt. 12 lb

Size 18 x 32" Small

Cat# 10023 Wt. 12 lb

Size 24 x 38" Large

Cat# 10024 Wt. 12 lb



APRON - VELCRO CLOSURE

Size: 18" x 32" Small

Cat# 20052 Wt. 12 lb

Size: 24" x 36" Medium

Cat# 20054 Wt. 12 lb

Size: 24" x 38" Large

Cat# 20055 Wt. 12 lb



APRON RACK

Cat# 10027 Wt. 5 lb

COMBINATION APRON & GLOVE RACK

Cat# 10029 Wt. 5 lb



IMAGING AIDS

MARKERS

R & L MARKER CLIP

Cat# 10016 Wt. 1 lb



VD & DV MARKER CLIP

Cat# 10015 Wt. 1 lb



CUSTOM R & L MARKER

add 2 or 3 initials
per pair right & left

Cat# 30021 Wt. 1 lb



CUSTOM MARKERS

YOUR CHOICE OF WORDING

Cat# 30030 Wt. 1 lb

THE “SCRUFFER” (ORANGE CLAMP)

Cat# 10039 Wt. 1 lb

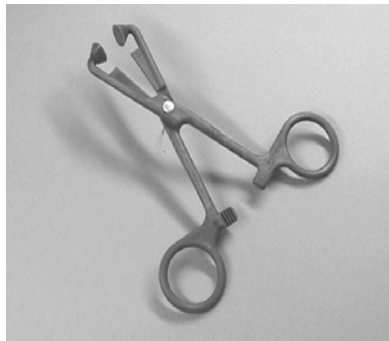

IMAGING AIDS

LEADED VINYL

ALL LEADED VINYL IS 1.0MM LEAD EQUIVALENT

5" x 12" VINYL COATED LEAD

Cat# 20082

Wt. 3 lb

6" x 10" VINYL COATED LEAD

Cat# 20083

Wt. 3 lb

7" x 17" VINYL COATED LEAD

Cat# 20084

Wt. 4 lb

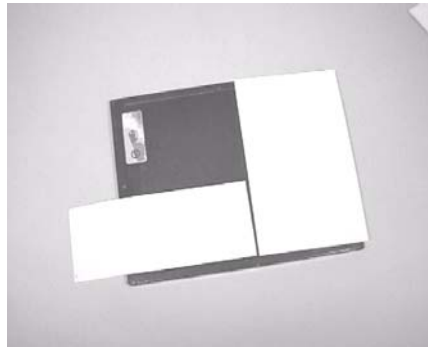

8½" x 17" VINYL COATED LEAD

Cat# 20085

Wt. 4 lb

SCREEN CLEANER

AGFA CUREX SCREEN CLEANER

Cat # 50300

500 ml Bottle

Wt. 2 lb



IMAGING AIDS

ELAPSED MINUTE MARKER

(leaded to show up on radiographs - 1 - 2 - 3 - 4 - 5 - 8
- 10 - 15 - 30 - 45 min with movable arrow)

Cat# 20014

Wt. 1 lb

ELAPSED HOUR MARKER

(leaded to show up on radiographs - 1/4 - 1/2 - 1 - 2 - 3 -
6 - 12 - 24 - 48 Hr with movable arrow)

Cat# 20015

Wt. 1 lb

VIEW BOXES

Desktop or Wall Mount

Single Bank

Cat# 10040

Wt. 15 lb

Double Bank

Cat# 10041

Wt. 24 lb

GRIDS

**UNLESS OTHERWISE SPECIFIED, ALL GRIDS WILL BE
10 OR 12:1 RATIO - 103 LINES PER INCH
(OTHER SIZES AVAILABLE – BUCKY GRIDS AVAILABLE)**

8x10

Cat# 40056

Wt. 5 lb

10x12

Cat# 40058

Wt. 6 lb

14x17

Cat# 40060

Wt. 8 lb

CASSETTE & SCREENS

NEW PUSH-BUTTON CASSETTES AND SCREENS.

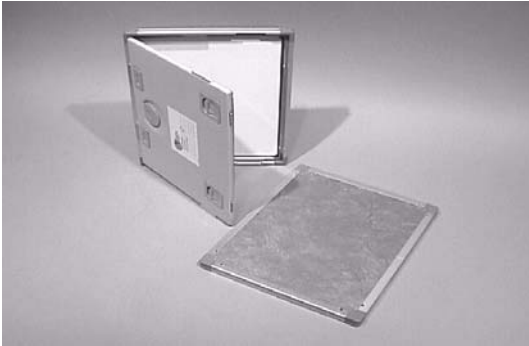

Blue Rare Earth—800 speed screens incorporates the newest technology. They provide high speed with low noise and are intended for Radiographic applications where very high speed is important. This would be an 800 speed system with IR B film. A 400 speed system would be achieved with IR M film (half-speed Blue).

Ortho Rare Earth (400 Green emitting). These screens are intended for general radiographic applications. A 400 speed system is achieved with used with full speed Ortho (green) film, such as IR G.

100 SPEED GREEN (DETAIL CASSETTES)

(WHEN USED WITH IR G OR EQUIV)

8 x10	Cat# 50000	Wt. 5 lb
10 x 12	Cat# 50005	Wt. 8 lb
14 x 17	Cat# 50010	Wt. 12 lb

CASSETTE & SCREENS

100 OR 200 SPEED BLUE (DETAIL CASSETTES)

(200 SPEED WHEN USED WITH **IR B** OR EQUIV)

(100 SPEED WHEN USED WITH USE WITH **IR M** OR EQUIV)

8 x10	Cat# 50012	Wt. 5 lb
10 x 12	Cat# 50014	Wt. 8 lb
14 x 17	Cat# 50016	Wt. 12 lb

400 SPEED GREEN

(WHEN USED WITH **IR G** OR EQUIV)

8 x10	Cat# 50081	Wt. 5 lb
10 x 12	Cat# 50082	Wt. 8 lb
14 x 17	Cat# 50089	Wt. 12 lb

400 OR 800 SPEED BLUE

(400 SPEED WHEN USED WITH USE WITH **IR M** OR EQUIV)

(800 SPEED WHEN USED WITH **IR B** OR EQUIV)

8 x10	Cat# 50090	Wt. 5 lb
10 x 12	Cat# 50092	Wt. 8 lb
14 x 17	Cat# 50095	Wt. 12 lb

OTHER SIZES AVAILABLE ARE AVAILABLE -
FROM 5 X 7 INCH TO 14 X 36 INCH.

CALL WITH YOUR REQUESTS OR FOR MORE INFORMATION
BE SURE TO SPECIFY WHICH SPEED YOU WANT WHEN ORDERING

DARKROOM EQUIPMENT



FLUORESCENT SAFELIGHT

Cat#
10010 wt. 6 lb



SAFELIGHT 15W GBX-2

6.5 inch, 15 watt

Cat# 10014

Wt. 6 lb

(screw-in, add \$15.00 for ceiling or wall mount)

BRITE LITE)

FOOT SWITCH TO CONTROL INTENSITY

Cat# 10005

Wt. 8lb



POLYBIN" DARKROOM FILM BIN



Lightproof, ABS plastic,
For counter-top or
vertical mounting

Large: holds 8 x10,
10 x12, & 14 x17 films

Cat# 10001 Wt. 12lb

FILM IMPRINTER

(battery operated—for use with im-
printed flash cards)

Cat# 10020 Wt. 7 lb



SPECULUMS

ASSISTS IN U.G.I. ESOPHAGRAM, ETC.

Speculum is useful for passing stomach tube in the conscious patient. The speculum is held in check by the feline/canine teeth going through the two large holes. By holding jaws firmly closed any chance of biting the tube is eliminated. The hardened blue nylon resists chewing and can be cold sterilized for reuse

SMALL SPECULUM



Smaller size works well on cats and smaller dogs. 6mm opening. 18fr.

Cat# 10080 Wt. 1 lb.min

MEDIUM SPECULUM

A 3/8 round hole through the center allows a stomach tube to pass through. .9mm opening



Cat# 10081 Wt. 1 lb.min

LARGE SPECULUM

6" x 2" will take up to a 3/8' stomach tube.



Cat# 10082 Wt. 1 lb.min

EQUINE RADIOGRAPHY

CASSETTE HOLDERS

- Specially made to accommodate all 8" x 10" cassettes (including 3M Contact Tunnel with vinyl holder)
- Also available in 10" x 12", 7" x 17", and 24 x 30 cm
- Assures compliance with State and Federal Regulations regarding Radiation Safety
- Grips are easily handled with lead gloves
- Quickly changes for right or left use
- Sturdy all metal construction

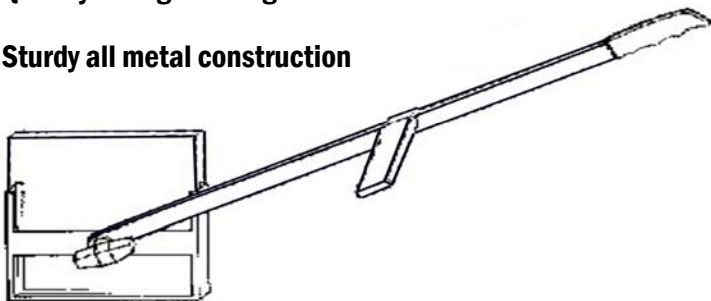

8 X 10 INCH

CAT# 40001

8 X 10 INCH FOR 3M

CAT# 40002

10 X 12 INCH

CAT# 40003

24 X 30 CM

CAT# 40005

7 X 17 INCH

CAT# 40004

TO ORDER:

CALL 1-800-340-XRAY WITH COMPLETED FORM-
OR FAX THIS PAGE TO: 541 - 248 - 3465

Item #	Weight	Quantity	Price Each	Total Price
TOTAL WEIGHT		SUBTOTAL		
SHIPPING WILL BE ADDED TO INVOICE [Based on current UPS charges]				
RESIDENTIAL ADDRESS - ADD \$3.00				
TOTAL				

SHIP TO: RESIDENTIAL ADDRESS CHECK HERE
(SORRY, UPS CANNOT SHIP TO PO BOXES)

Name &/or Company

Address

City, State, Zip

Phone

Fax

**Imaging Resources, Inc.
Post Office Box 39
Albany, OR 97321-0013**